



COLLECTION 2020-2021



Vous allez
aimer votre
porte de garage



V2-05



Vous allez
aimer **votre**
porte de garage



SOMMAIRE

Présentation	4-5
Norme NF	6-7
Types de portes	8-9
Isoladoor 60mm	10-11
Isoline 40mm	12-17
Isoprima 40mm	18-21
Isoslides 40mm	22-27
Isobas 40mm	28-29
Isobat 40mm	30-37
Kaméléo	38-41
Isobois	42-43
Panneaux	44-49
Personnalisation	50-61
Motorisations et accessoires	62-66
SDA c'est aussi	67



Vous allez aimer **votre** porte de garage



La porte de garage est le premier élément visible de votre maison. Plus qu'un simple moyen d'accès, elle est devenue un objet de décoration à part entière, le reflet de votre personnalité et de votre style de vie.

Symbole de convivialité et d'accueil, elle se doit d'être personnalisée à votre image, tout en étant thermiquement performante et sécurisée. C'est pour répondre à ces critères que SDA fabricant français de portes de garage depuis plus de 25 ans vous propose une gamme complète de portes de garage fabriquées sur mesure et totalement personnalisables.

SDA conçoit et fabrique votre porte selon vos envies...

COLLECTION 2020-2021



Des portes de garage



RÉSISTANCE AU VENT



SÉCURITÉ



MANŒVRABILITÉ



ANTI-CORROSION



PERMÉABILITÉ À L'AIR



ENDURANCE MÉCANIQUE



Garage de qualité



ÉTANCHÉITÉ



RÉSISTANCE THERMIQUE



PORTES DE GARAGE
SELON MODÈLES

La qualité est la priorité absolue au sein de l'usine de production SDA.

C'est pour cette raison que SDA a fait certifier ses produits.

Le Label NF est une garantie supplémentaire pour le client final, gage d'un produit de grande qualité ayant subi de nombreux tests d'endurance, d'étanchéité à l'air, à l'eau et de sécurité.

L'obtention du label NF est un engagement volontaire de SDA de soumettre ses produits et ses méthodes à un bureau de contrôle indépendant chargé de valider la qualité de ses productions et de son processus de fabrication.

Quel type de porte de

Il existe plusieurs systèmes de refoulement pour les portes de garage, SDA vous propose de choisir dans sa gamme complète, le mécanisme qui correspondra le mieux à votre confort d'utilisation. De plus, différents niveaux d'isolation sont disponibles, adaptés à votre niveau d'exigence en termes d'isolation thermique.

Refoulement plafond



Isola  door

+25%
isolation

La performance énergétique

Panneaux épaisseur 60 mm

Équilibrage par ressorts de torsion

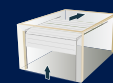

Isoline

La porte 100% personnalisable

Panneaux épaisseur 40 mm

Équilibrage par ressorts de torsion

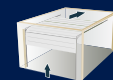

ISOPRIMA

La qualité sans artifices

Panneaux épaisseur 40 mm

Équilibrage par ressorts de traction

garage souhaitez-vous ?

Déplacement latéral



Basculante



Battante

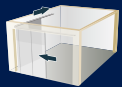

Isoslide

Confort optimal avec ouverture partielle

Panneaux épaisseur 40 mm motorisée

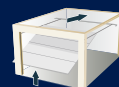

Isobas

Confort et robustesse

La porte basculante
Equilibrage par contre poids

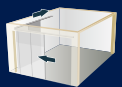

Isoslide P

Accès simplifié avec portillon de service

Panneaux épaisseur 40 mm motorisée ou manuelle

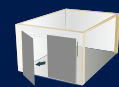

Isobat

Porte battante haut de gamme

100% sur mesure, 100% personnalisable



Kaméléo

Un concept global

La porte de garage se fond dans
l'ensemble de la façade



Isoboïs

La porte sectionnelle tradition

Panneaux épaisseur 40 mm motorisée
ou manuelle

COLLECTION 2020-2021

Isola door

La performance **énergétique**
Panneaux de 60mm d'épaisseur



Equipée de panneaux d'épaisseur 60 mm, la porte ISOLADOOR est sans aucun doute la porte de garage la plus isolante du marché. Avec ce type de porte et ses accessoires, le coefficient d'isolation globale est de 25 % supérieur à une porte sectionnelle classique. La porte s'efface sous le plafond du garage, grâce à son sens de refoulement, les murs latéraux restent libres permettant d'y intégrer tous types de rangements. En version motorisée (optionnelle), l'accès au garage est très rapide, la motorisation accompagne le mouvement de la porte, équilibré par de puissants ressorts de torsion.

Coefficient d'isolation thermique des panneaux : $U = 1,20 \text{ W (m}^2 \cdot \text{k)}$
Coefficient d'isolation phonique de la porte : $R_w = 30 \text{ dBa}$

Les produit

- Performance thermique exceptionnelle (panneaux de 60mm d'épaisseur)
- Rails montés avec rupture de pont thermique
- Joint d'étanchéité bas à triple lèvres
- Double joint au linteau
- 15 modèles de panneaux standard
- Tous types de laquages standard ou premium
- Décors Alunox personnalisés
- Equilibrage par ressorts de torsion
- Quincaillerie blanche



Rails verticaux avec profil de rupture de ponts thermiques



Joint bas à triple lèvre, isolation et étanchéité parfaite au sol

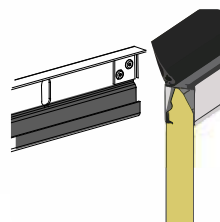

Joint haut sur traverse + joint à lèvre sur panneau haut



Porte



à refoulement plafond





Porte

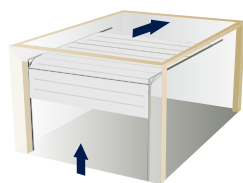

Isoline

La performance 100% personnalisable
Panneaux de 40mm d'épaisseur

Equipée de panneaux d'épaisseur 40 mm, la porte ISOLINE est le choix de la qualité allié à celui de la performance.

Une variété incomparable de finitions et d'accessoires peuvent lui être ajoutés permettant ainsi une personnalisation selon les critères de chacun.

La porte s'efface sous le plafond du garage, grâce à son sens de refoulement, les murs latéraux restent libres permettant d'y intégrer tous types de rangements.

En version motorisée (optionnelle), l'accès au garage est très rapide, la motorisation accompagne le mouvement de la porte, équilibré par de puissants ressorts de torsion.

Coefficient d'isolation thermique des panneaux : $U = 1,51 \text{ W (m}^2 \cdot \text{k)}$
Coefficient d'isolation phonique de la porte : $R_w = 30 \text{ dB}$

Les produit

- 45 modèles de panneaux au choix
- Tous types de laquages standard ou premium
- Plaxages RénoLit (revêtement décoratif de haute protection)
- Plus de 60 hublots standard et LINETECH
- Portillon intégré en option
- Décors Alunox personnalisés
- Equilibrage par ressorts de torsion
- Quincaillerie blanche

à refoulement plafond



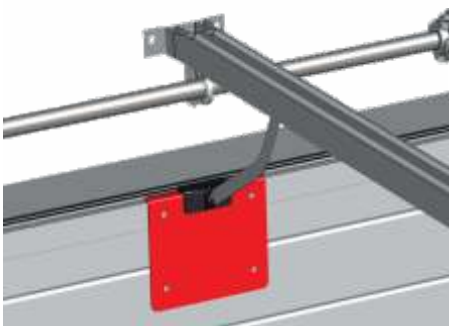

Plaque renfort pour liaison du bras moteur

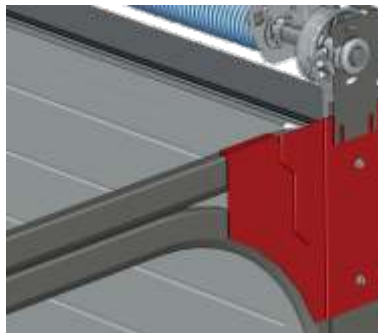

Renfort d'angle sur courbe de renvoi



Equerre renforcée sur barre d'écartement



Ressorts de torsion avec laquage poudré



Profil support joint d'étanchéité en linteau



Vis à tête torx blanches exclusives SDA

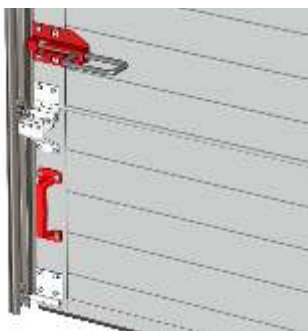

Verrou et poignée de manoeuvre en standard

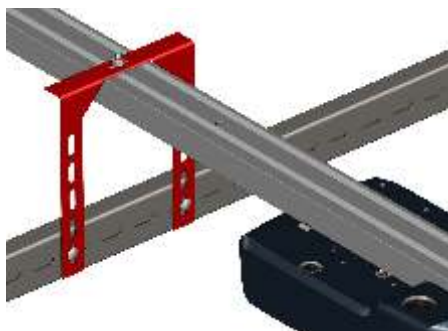

Support moteur indépendant



Quincaillerie et visserie blanche

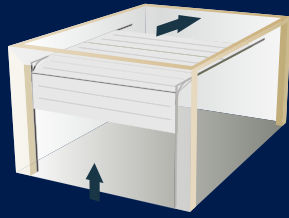

Zoom Technique Isoline

La qualité Premium 100% personnalisable

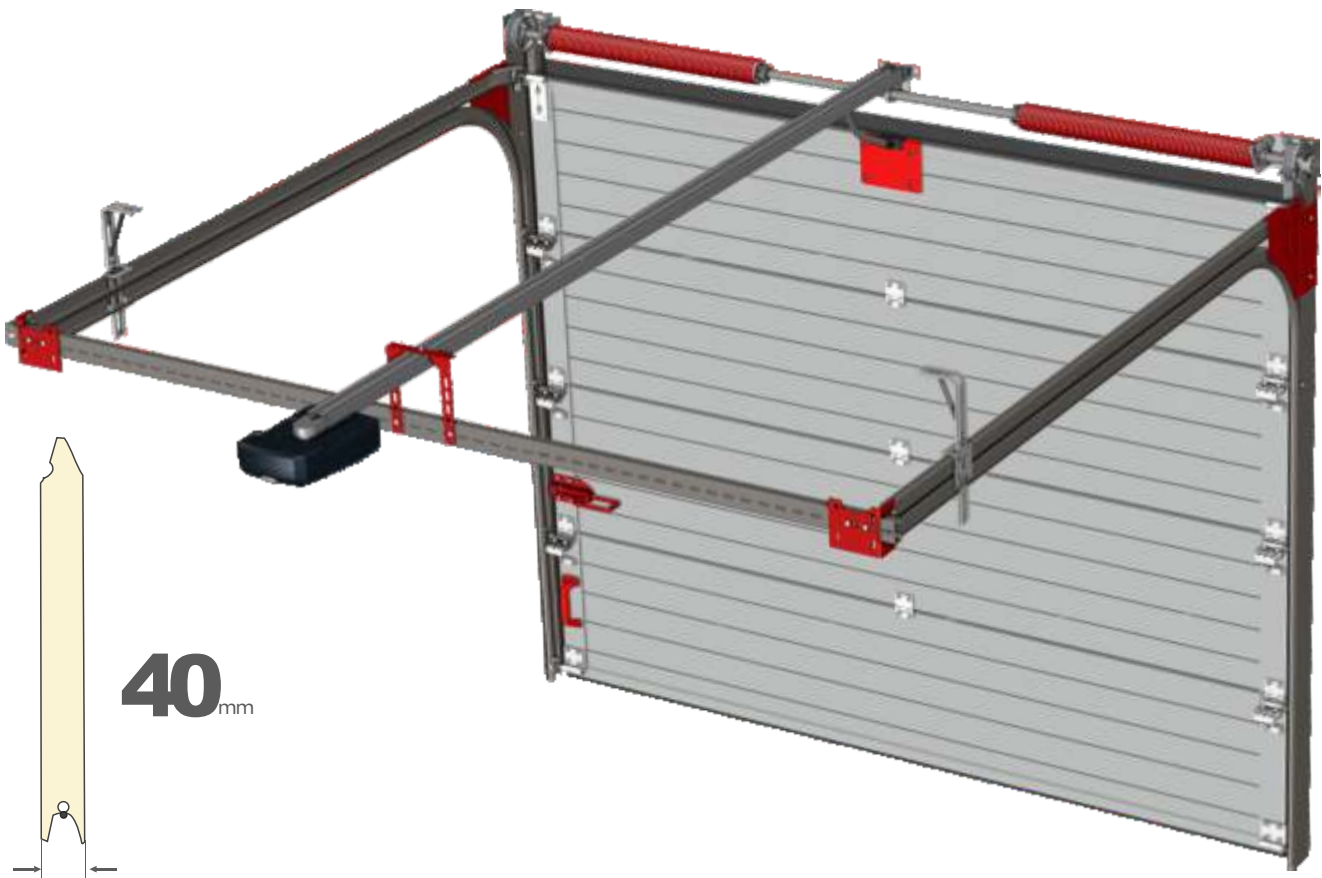

40_{mm}

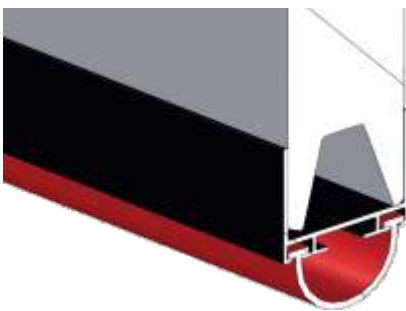

Joint à bulle EPDM
sur panneau bas



Joint haut à lèvre EPDM

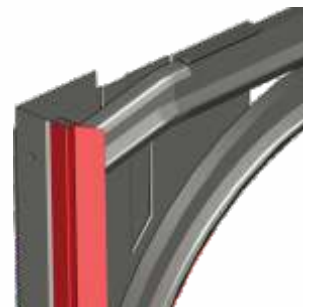

Joints à lèvres EPDM
sur rails verticaux

Zoom Technique

Portillon

Isoline

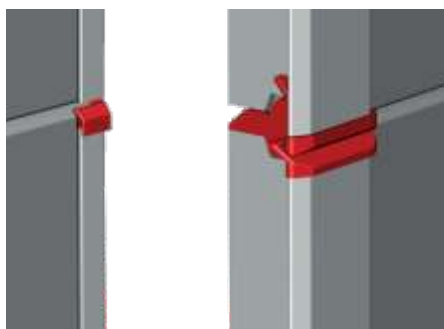
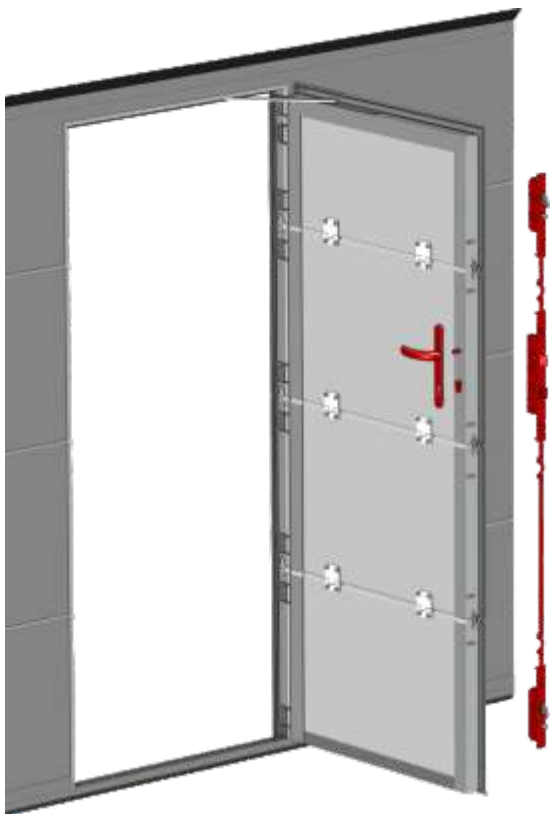

Embouts d'articulation sur dormant et ouvrant



Ferme-porte encastré avec blocage à 90°

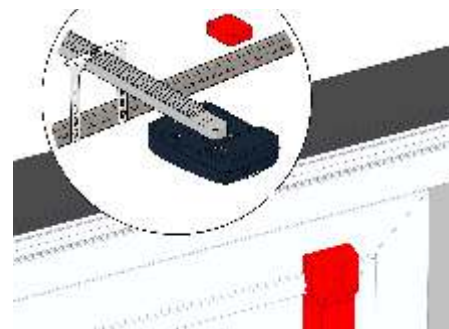

Sécurité radio accouplée au moteur



Charnières réglables hautes performances

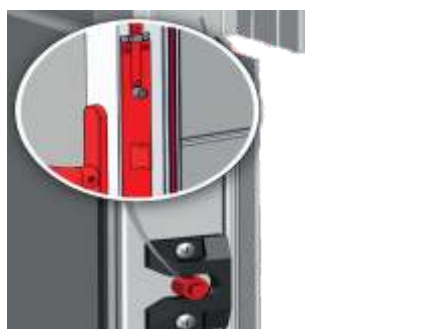

Doigts de centrage réglables par excentrique

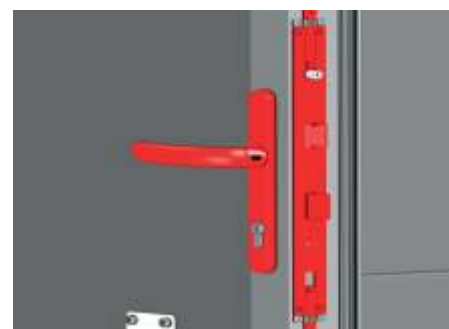

Serrure 3 points (5 points d'ancrage)



Joint d'étanchéité EPDM sur ouvrant



Joint d'étanchéité EPDM sur dormant

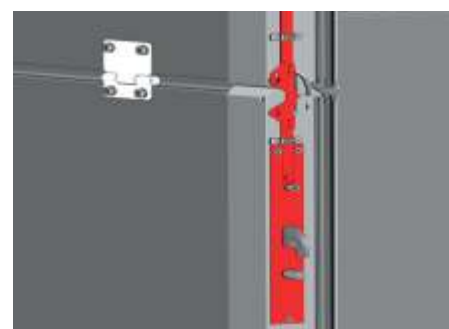

Serrure à crochets haute et basse



Le confort et la sécurité 40mm

Robuste et fiable, le portillon intégré de la porte ISOLINE apporte confort d'utilisation et sécurité.

Réalisé avec des profils en aluminium développés par SDA, il s'intègre parfaitement dans le tablier de la porte.

Tous les profils d'encadrement sont thermolaqués à la couleur de la porte.

Le seuil du portillon en aluminium anodisé d'une hauteur de 20 mm est très discret (sur portes < 3000 mm de large).

Doté d'un système de sécurité radio (portes motorisées), d'un ferme-porte encastré avec blocage à 90° et d'une serrure de sécurité 3 points (5 points d'ancrage).

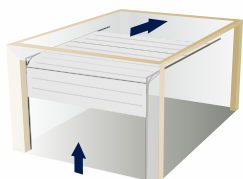

ISOPRIMA

Le style et la simplicité Panneaux de 40mm d'épaisseur

Porte sectionnelle isolée, à ouverture verticale et refoulement sous le plafond. Panneaux d'épaisseur 40mm suivant la gamme de panneaux ISOPRIMA, équipés de profils anti-pince doigts.

Cette porte nécessite de très faibles encombrements au linteau et s'intègre dans tous types de configuration.

La porte s'efface sous le plafond du garage, grâce à son sens de refoulement, les murs latéraux restent libres permettant d'y intégrer tous types de rangements.

En version motorisée (optionnelle), l'accès au garage est très rapide, la motorisation accompagne le mouvement de la porte, équilibré par de puissants ressorts de torsion.

Coefficient d'isolation thermique des panneaux : $U = 1,51 \text{ W (m}^2 \cdot \text{k)}$

Coefficient d'isolation phonique de la porte : $R_w = 25 \text{ dB}$

Les produit

- 45 modèles de panneaux au choix
- Tous types de laquages standard ou premium
- Large choix de hublots standard
- Décors Alunox personnalisés
- Equilibrage par 4 ressorts de traction
- Equipée de double roulettes
- Quincaillerie blanche
- La solution idéale pour de très faibles encombrements
- Dimensions sur mesure (largeur maxi 4000mm, hauteur maxi 2500mm)





Porte à refoulement plafond



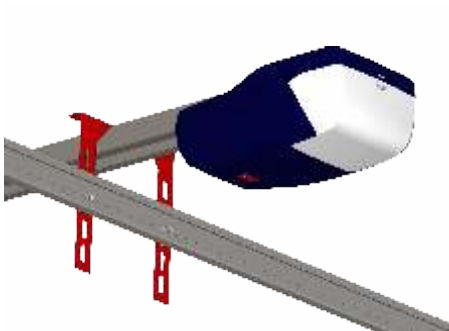

Motorisation BFT Tiziano
et système easyfixe

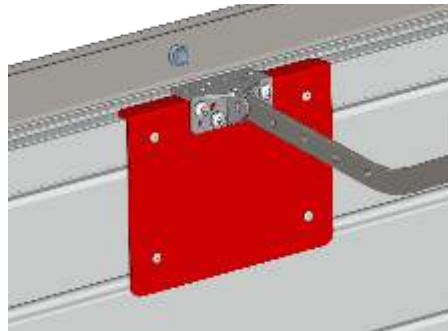

Plaque d'arrimage
moteur



Cache ressorts
(en option)

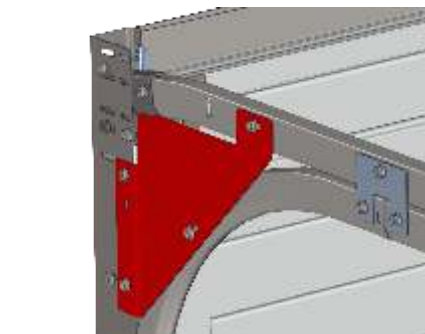

Plaque renfort sur courbes



Manchonnage du rail



Double roulettes

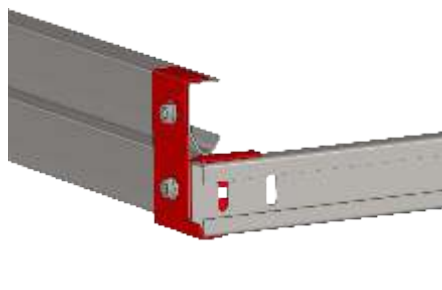

Support de barre d'écartement



Double ressorts de traction
(Ressorts et câbles prémontés
et prétendus en option)

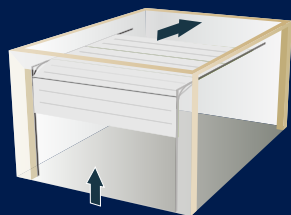

Zoom Technique

ISOPRIMA

Simple et robuste

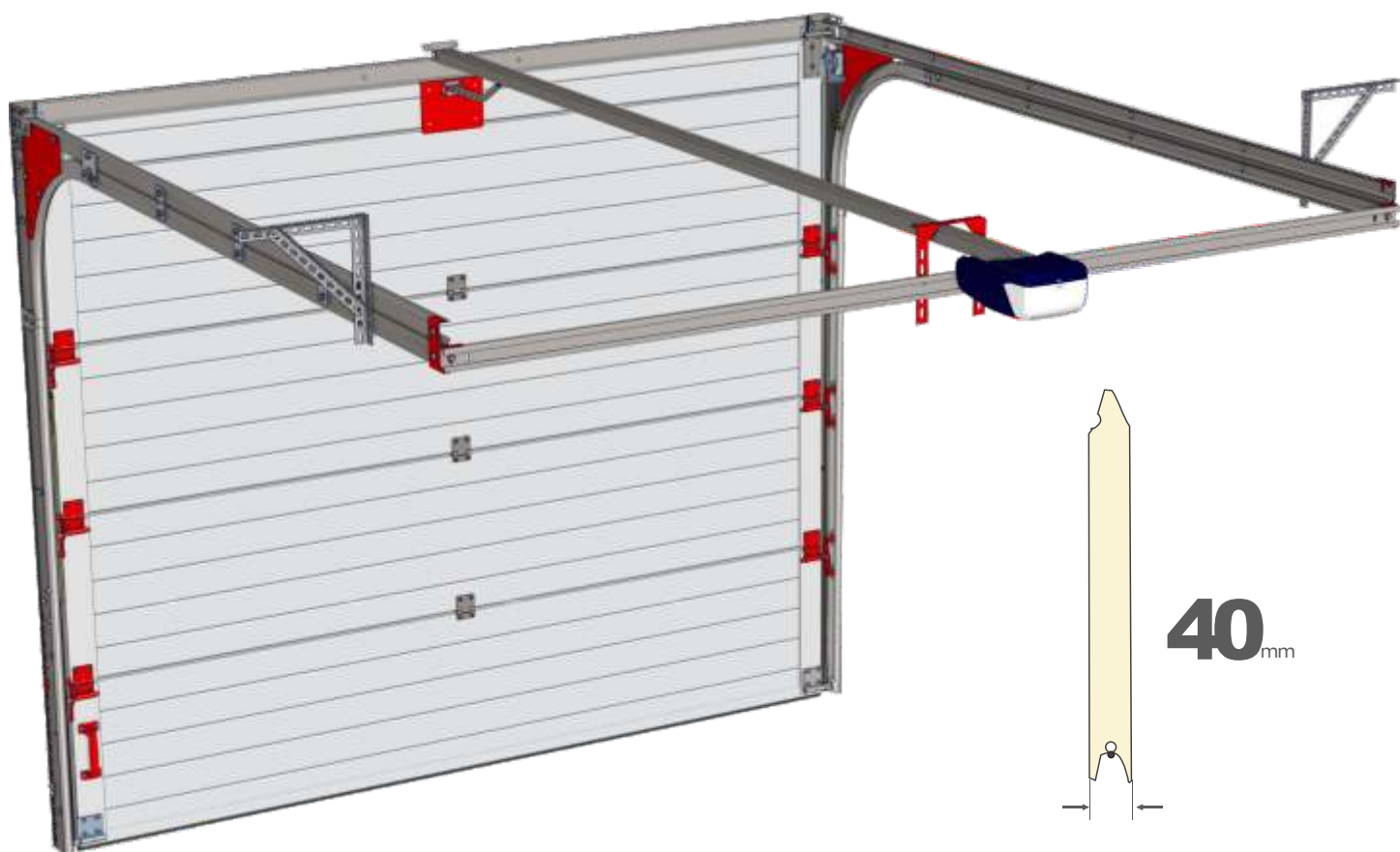



Porte

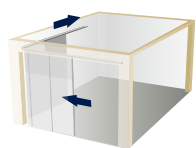

Isoslide

La porte latérale haut de gamme Panneaux de 40mm d'épaisseur

Equipée de panneaux d'épaisseur 40 mm, la porte ISOSLIDE est une porte latérale de qualité supérieure. Avec un pré-cadre intégral en aluminium thermolaqué, de nombreux composants en aluminium, ainsi que des joints efficaces et discrets, la porte ISOSLIDE est une référence sur le marché.

Fabriquée sur mesure en fonction des dimensions et contraintes de refoulement.

La porte s'efface latéralement dans le garage, laissant disponible l'intégralité du plafond.

En version motorisée (optionnelle), l'accès au garage se fait en toute rapidité, la motorisation accompagne également le mouvement de la porte.

Coefficient d'isolation thermique des panneaux : $U = 1,51 \text{ W (m}^2 \cdot \text{k)}$
Coefficient d'isolation phonique de la porte : $R_w = 30 \text{ dB}$

Les produit

- 44 modèles de panneaux au choix
- Tous types de laquages standard ou premium
- Plaxages Rénolit (revêtement décoratif de haute protection)
- Plus de 40 hublots standard et LINETECH
- Pré-cadre intégral en aluminium thermolaqué
- Dispositif d'ouverture partielle réglable sur porte motorisée
- Portillon intégré côté fermeture ou côté refoulement sur la version Isoslide P
- Décors Alunox personnalisés
- Quincaillerie blanche

e à déplacement latéral



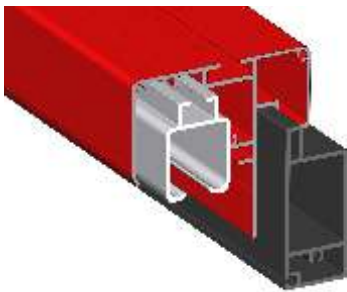

Précadre avec profil de rail monobloc

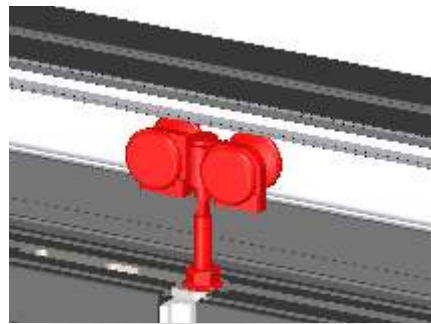

Chariots tandem avec roulettes sur roulements



Courbe renforcée

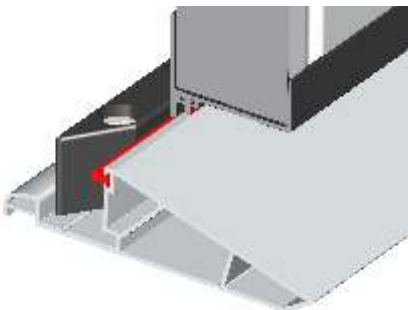

Seuil bas drainé en aluminium avec évacuation d'eau

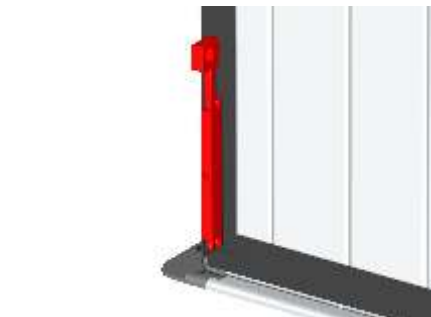

Targette de verrouillage de sécurité



Plaque renfort pour liaison du bras moteur

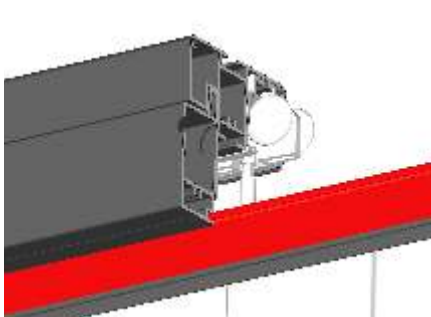

Joint d'étanchéité EPDM sur linteau

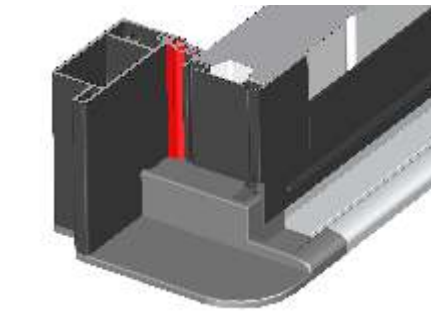

Joint d'étanchéité tubulaire EPDM côté ouverture

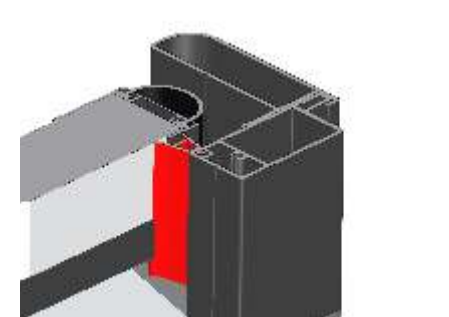

Joint tubulaire à lèvre EPDM côté fermeture

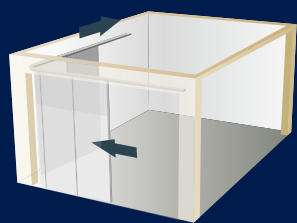

Zoom Technique

Isoslide

Esthétique et fonctionnelle

Montage avec motorisation dans le refoulement*

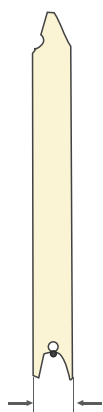

40_{mm}

Montage avec motorisation derrière le linteau*

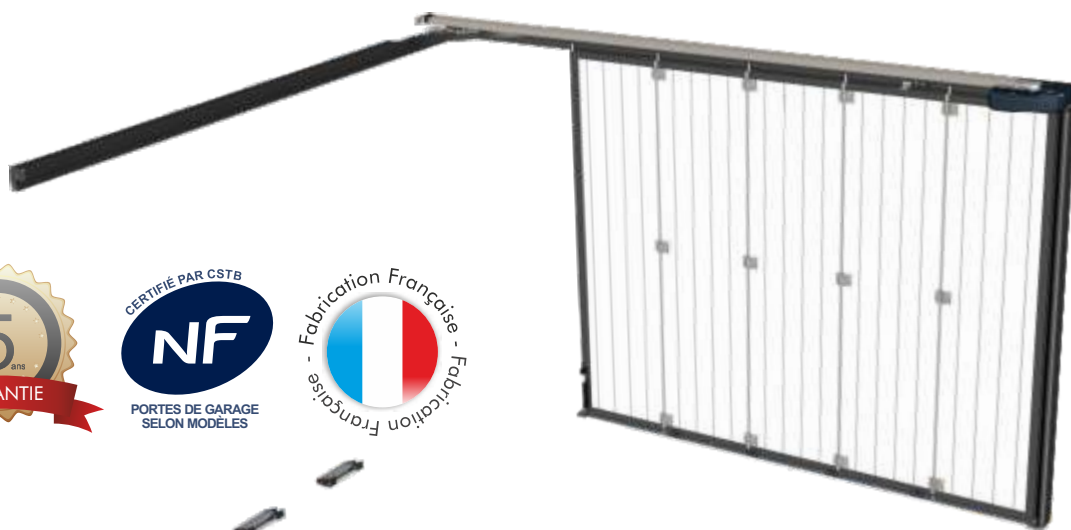

*Suivant contraintes techniques

Isoslide P

Portillon inverse
sens refoulement



Isoslide P

Portillon sens
refoulement



Serrure 3 points
(5 points d'ancrage)



Poignée de serrure
Aluinox ergonomique



Sécurité radio
accouplée au moteur



Gâches de serrure
réglables



Double charnières
renforcées

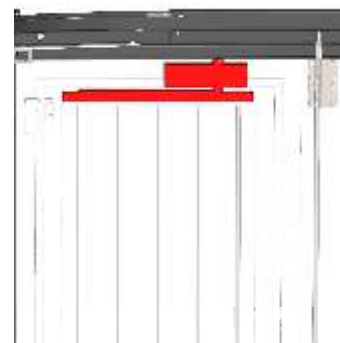

Ferme-porte
(sur portillon sens refoulement)



Confort optimal avec portillon de service

Robuste et fiable, le portillon intégré de la porte ISOSLIDE apporte confort d'utilisation et sécurité.

Réalisé avec des profils en aluminium développés par SDA, il s'intègre parfaitement dans le tablier de la porte.

Disponible côté fermeture ou côté refoulement de la porte (suivant encombrements disponibles).

Equipé d'une poignée ergonomique intérieure/extérieure, la manipulation de ce portillon est très aisée.

Doté d'un système de sécurité radio (portes motorisées), d'un ferme-porte encastré avec blocage à 90°, et d'une serrure de sécurité 3 points (5 points d'ancrage sur portillon côté fermeture).

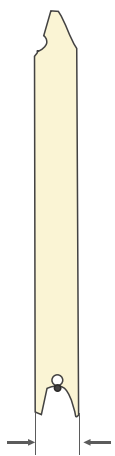

40_{mm}



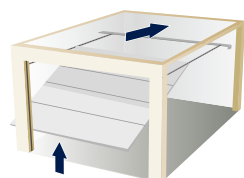

Isobas

Confort et robustesse
Panneaux de 40mm d'épaisseur

Equippée de panneaux d'épaisseur 40 mm, la porte ISOBAS est une porte basculante de qualité supérieure. Sans rails de retours horizontaux, elle peut s'installer dans quasi tous les environnements.

Coefficient d'isolation thermique des panneaux : $U = 1,51 \text{ W (m}^2 \cdot \text{k)}$
Coefficient d'isolation phonique de la porte : $R_w = 30 \text{ dB}$



Equilibrage par
contrepois latéraux



Serrure 3 points
(5 points d'ancrage)



Serrure de sécurité
avec canon européen



Double motorisation BFT



Parachutes
sur crémaillères latérales

Porte basculante







Porte battante en menuiserie aluminium à rupture de pont thermique Fabrication 100 % sur mesure, 20 types de montages possibles

Equipée de panneaux isolants avec remplissage en polyuréthane haute densité d'épaisseur 40 mm et de profils aluminium à rupture de pont thermique, la porte battante ISOBAT est un produit haut de gamme conçu pour isoler parfaitement votre garage.

Disponible en 1, 2, 3 ou 4 vantaux, elle est fabriquée 100% sur mesure pour s'adapter dans n'importe quelle configuration de pose.

De multiples types de montages et 20 choix de sens d'ouverture permettent de répondre aux critères de chaque utilisateur.

De plus, en termes de dimensions, la porte ISOBAT permet de réaliser des portes allant à des hauteurs de 2500 mm et 4000 mm en largeur.

Coefficient de conductivité thermique des panneaux $U = 1,51 \text{ W(m}^2\cdot\text{k)}$
Coefficient d'isolation phonique de la porte : $R_w = 30\text{dB}$

Les produit

- 20 modèles de panneaux de remplissage isolants au choix épaisseur 40 mm
- Possibilité de travailler en bi-coloration sur la face extérieure, coloris de panneaux et de cadre différents
- Tous types de laquages standard, fine texture et plaxages
- Large gamme de décorations Alunox suivant gamme ou personnalisées sur demande
- Nombreux modèles de vitrages ou hublots disponibles
- Possibilité d'intégrer une ou plusieurs traverses intermédiaires par vantail aux hauteurs désirées

La conception technique

- Profilés aluminium systématiquement à rupture de ponts thermiques
- Position des panneaux de remplissage horizontale ou verticale* (*suivant contraintes techniques)
- Assemblage mécanique des cadres avec équerres aluminium goupillées et collées
- Serrure 3 points à relevage en standard sur vantail de service
- Verrouillage des vantaux par crémone 2 points invisible, avec levier de manœuvre unique à mi-hauteur
- 3 ou 4 Paumelles suivant dimensions par vantail, posées en applique avec réglage sur 3 axes
- Seuil en aluminium anodisé PMR (personne à mobilité réduite) hauteur 14 mm

Porte battante





Paumelle aluminium

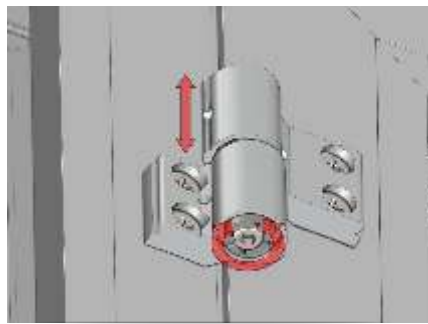

Réglage hauteur et profondeur



Caches paumelles

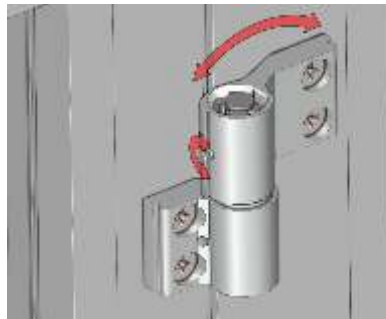

Réglage latéral

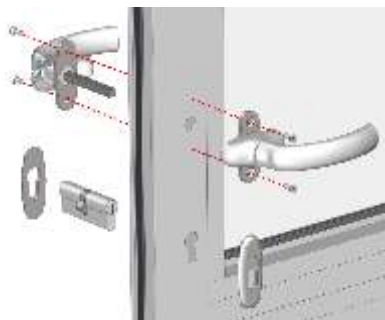

Poignées avec rosaces et canon de sécurité

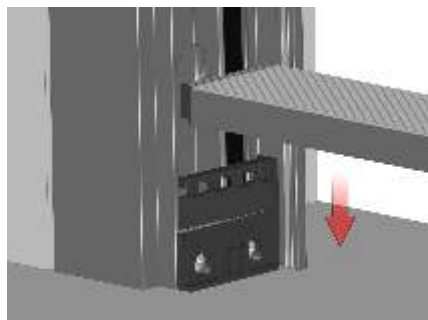

Seuil PMR hauteur 14mm (Personne à Mobilité Réduite)



Serrure 3 points

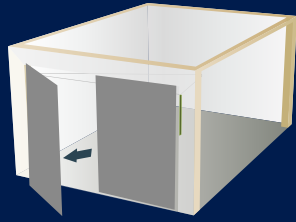

Zoom Technique Isobat

Fabrication 100% sur mesure

Exemple de porte 4 vantaux vue de l'extérieur

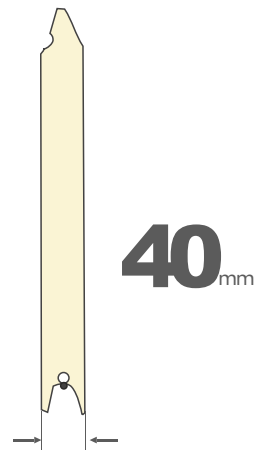
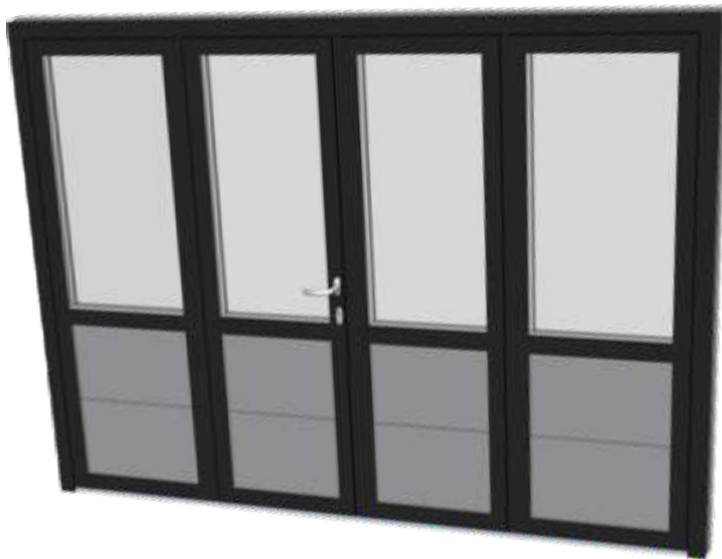

Exemple de porte 4 vantaux vue de l'intérieur



Verrouillage des
vantaux semi-fixes
par crémonne invisible
2 points

Fabrication 100% sur mesure, 20 types de montages possibles

1 VANTAUX

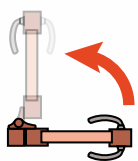

MONTAGE 1

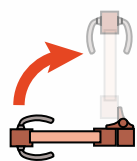

MONTAGE 2

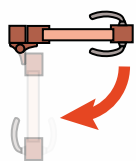

MONTAGE 3

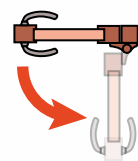

MONTAGE 4



Intérieur

2 VANTAUX

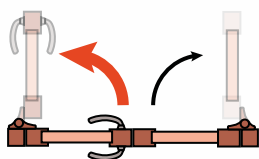

MONTAGE 5

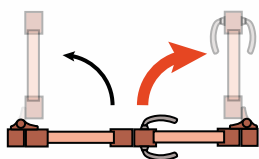

MONTAGE 6

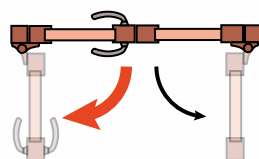

MONTAGE 7

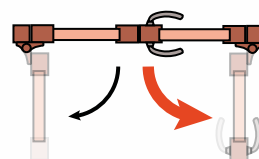

MONTAGE 8



Intérieur

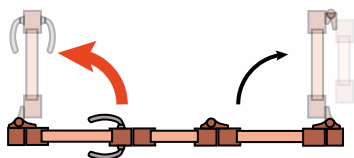

MONTAGE 9

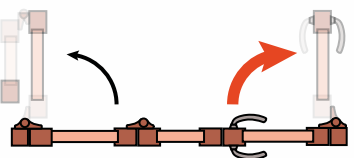

MONTAGE 10

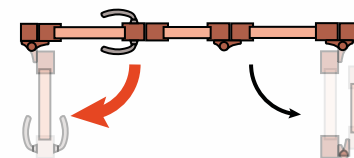

MONTAGE 11

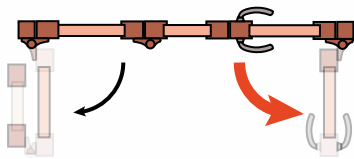

MONTAGE 12

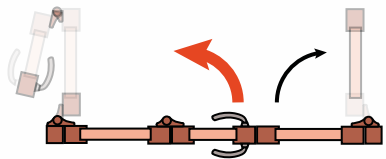

MONTAGE 13

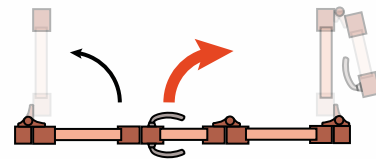

MONTAGE 14



3 VANTAUX

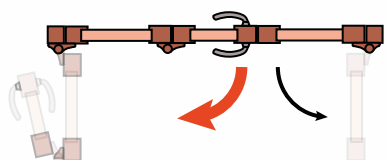

MONTAGE 15

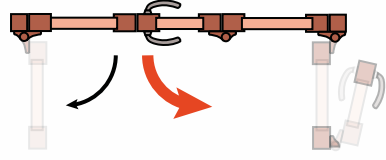

MONTAGE 16



Intérieur

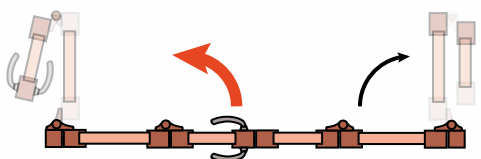

MONTAGE 17

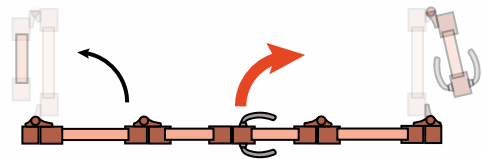

MONTAGE 18



4 VANTAUX

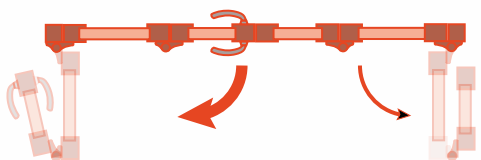

MONTAGE 19

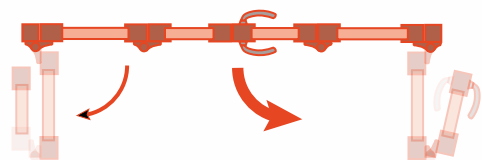

MONTAGE 20



Intérieur

Porte battante en menuiserie aluminium à rupture de pont thermique

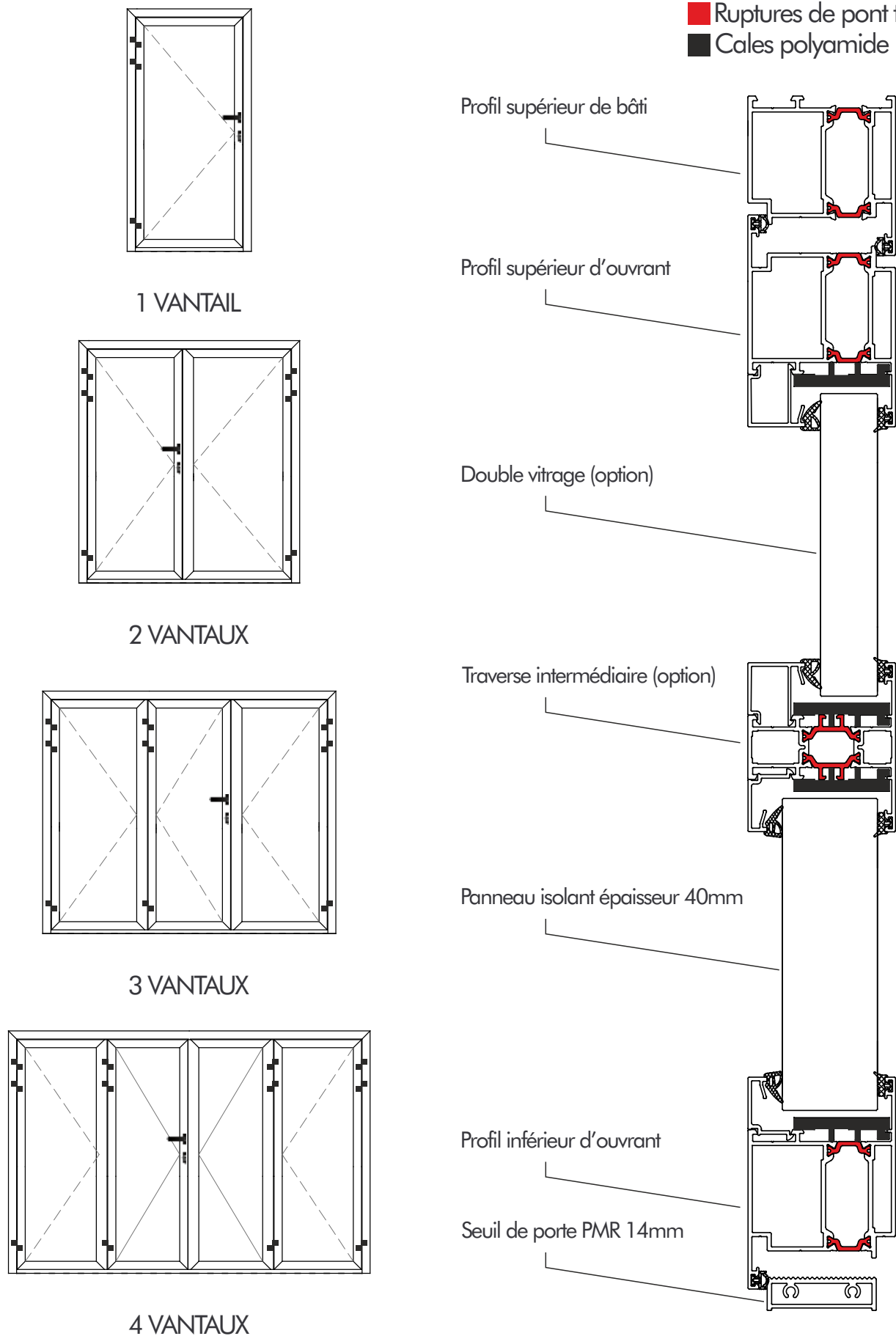

Configurez votre porte ISOBAT Personnalisation sans limites !

Demandez à votre spécialiste SDA
votre configuration sur mesure
réalisée avec **SDAonline**

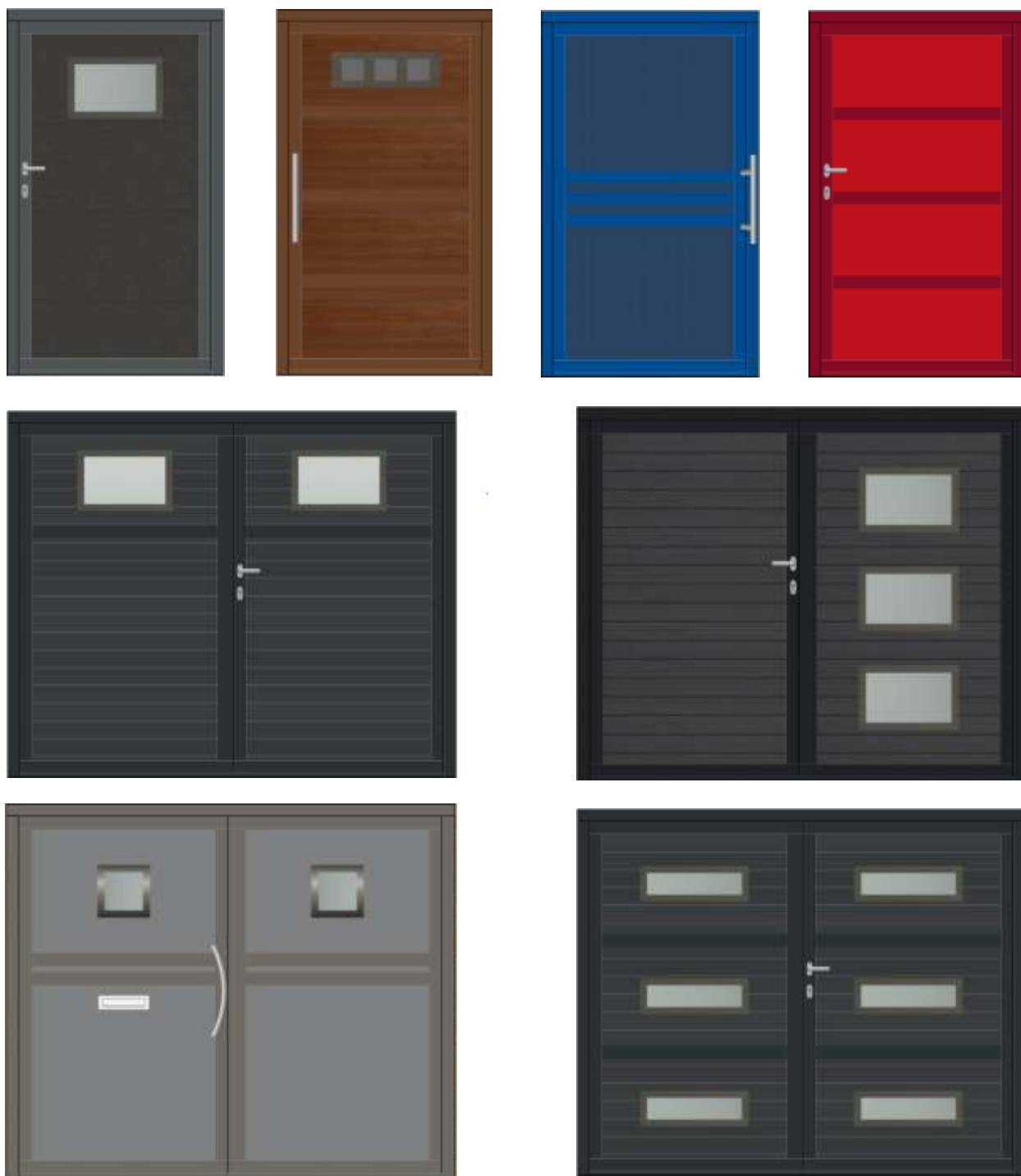

Exemples de configurations réalisées avec **SDAonline**

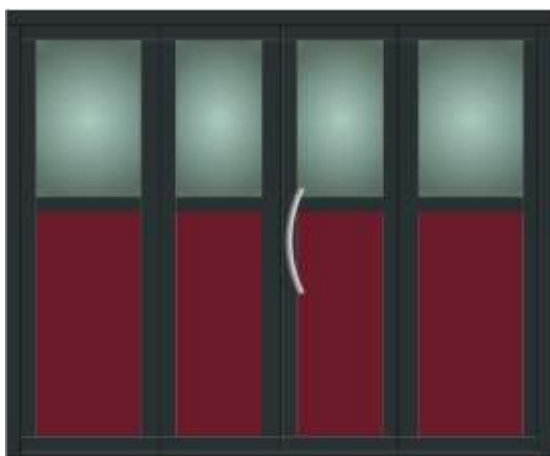
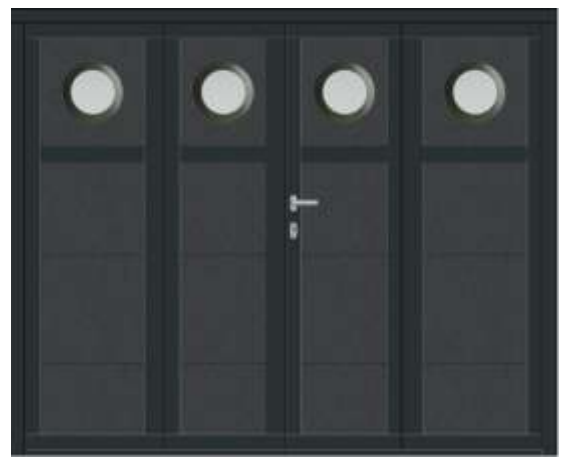
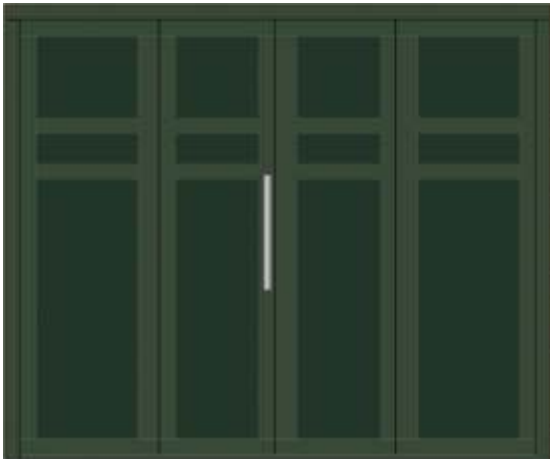
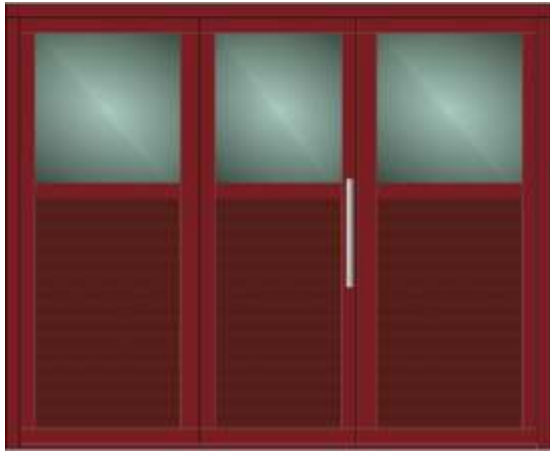





Kaméléo

Un concept global

Exclusive, la porte KAMÉLÉO ré-invente le design en s'intégrant dans la façade.

Chaque projet est unique et personnalisé : un très grand nombre de finitions sont disponibles pour intégrer harmonieusement la porte dans la façade.

Notre bureau d'études se charge de concevoir votre projet avec nos installateurs spécialisés.

Les produit

- Chaque porte est spécifique
- Optimise l'uniformité architecturale de la maison
- La porte de garage se fond totalement dans l'ensemble de la façade
- Habillage de façade esthétique et fonctionnel
- Lames filantes verticales ou horizontales
- Bardage identique à celui de votre maison

Porte intégrée dans la façade





Kaméléo

RENSON®

Le bardage exclusif

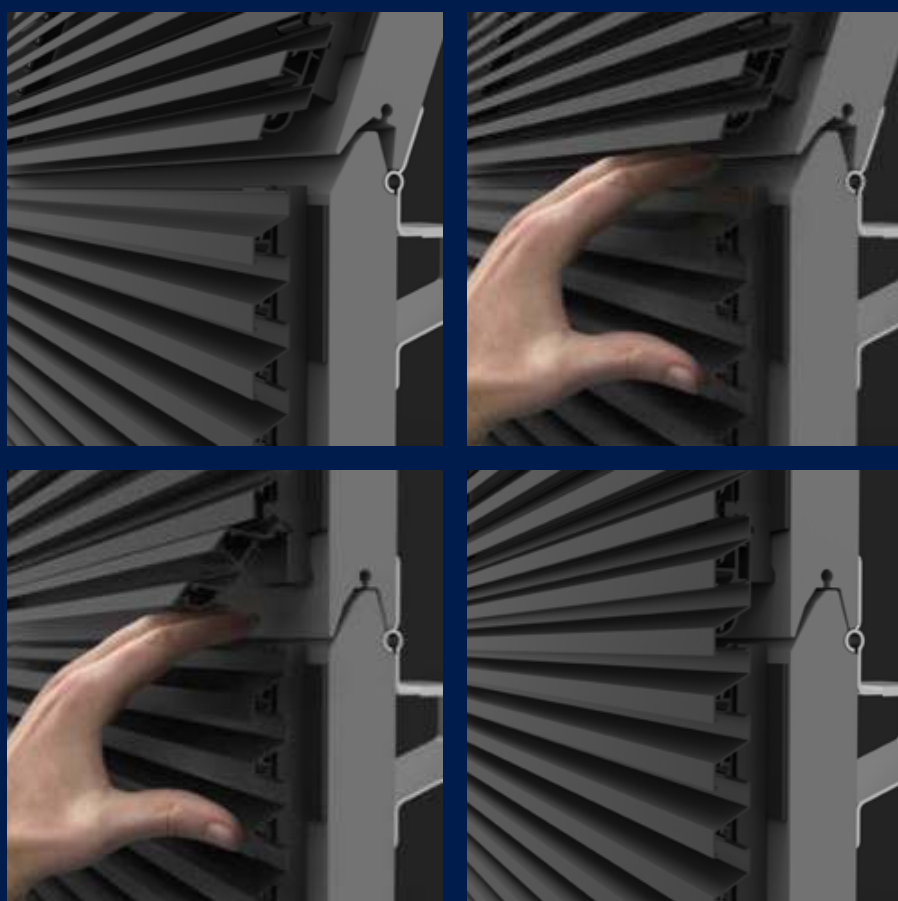

Système anti pince-doigt Linus

Pour les portes sectionnelles, Renson® a conçu un mécanisme spécial, breveté, pour éviter que les doigts puissent être coincés. Pour ce faire, le profil en aluminium se soulève dès qu'un doigt se trouve entre deux sections de la porte. Le profil revient ensuite de lui-même dans sa position initiale.





orte intégrée dans la façade





Isobois

La porte sectionnelle tradition

Avec le bois, nous laissons libre cours aux envies de nos clients.

Chaque porte est unique, personnalisée, de nombreuses essences et finitions sont réalisables.

Notre bureau d'études se charge avec nos installateurs spécialisés de concevoir chaque projet.

Les produit

- Confort identique à celui d'une porte sectionnelle
- Equilibrage par ressorts de torsion
- Nombreuses essences de bois disponibles
- Décors et finitions sur mesure
- Répond aux exigences des architectes bâtiments de France
- Portes exclusivement motorisées
- Chaque porte est unique





Porte en bois massif



Quel panneau s

Texture

Lisse

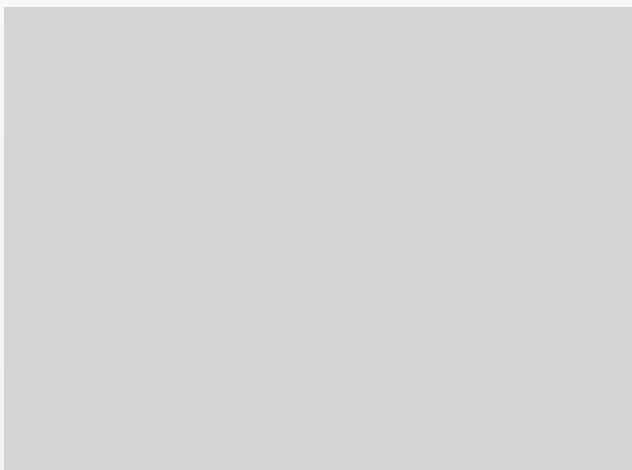

Veiné bois



ou

Type

Rainuré



Lisse

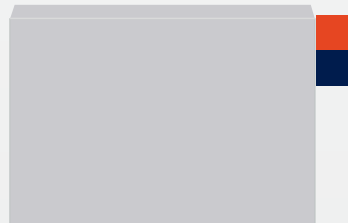

Monorainure

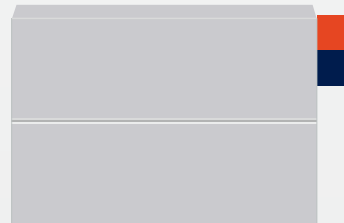

Monorainure haute



Mononervure

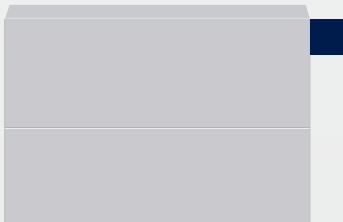

Cassette



Bandes verticales



Microrainures



Les panneaux sont disponibles en lisse  et/ou veiné bois 

souhaitez-vous ?

Texture lisse



Texture
veiné bois



Quelle finition



Couleurs Standard

Choisissez parmi notre gamme de 42 panneaux en standard, le modèle et la teinte que vous désirez.

Voir pages 38-39

Autres laquages gamme RAL

Choisissez la couleur de vos envies dans la gamme RAL qui propose près de 200 teintes.

Teintes en option avec plus-value



Laquages Premium sablés fines textures

SDA à sélectionné pour vous 5 teintes en finition sablée, très tendance à prix doux.



GRIS RAL 7016 SABLÉ



ROUGE RAL 3004 SABLÉ



GRIS 2900 SABLÉ



NOIR RAL 9005 SABLÉ



NOIR 2100 SABLÉ

Laquage Anti-Graffiti



Pour protéger votre porte contre le vandalisme et les graffitis, nous vous proposons en option un laquage Anti-Graffiti très performant.

Laquage Air Salin



Vous habitez en bord de mer ? Pensez au laquage air salin pour protéger votre porte pour ralentir la corrosion.

souhaitez-vous ?



Exemple : photo ci-dessus finition plaxage IRISH OAK



Plaxage RENOLIT Optez pour une finition d'exception !

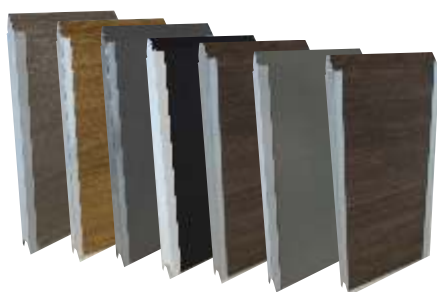

- Tenue exceptionnelle des couleurs dans le temps
- Résistance à l'air salin
- Résistant aux rayures
- Absorbe 95% des UV
- Film teint dans la masse
- Simple d'entretien



RENOLIT : une référence mondiale des décors plaxés.

Les films ultra-performants pour applications extérieures de RENOLIT sont un gage de qualité et de durabilité : leur structure polycouches protège les surfaces des panneaux exposés à l'extérieur.

Leur large palette permet une grande variété de coloris et de décors (+ de 100 finitions au choix).

Les produits de la gamme RENOLIT EXTERIOR mettent en valeur de manière fiable les panneaux de portes de garage.

EXCLUSIF!

Teintes proches du noir RAL 9005 sablé, du gris RAL 7016 sablé et du noir 2100 sablé disponibles avec l'option laquage Premium sur panneaux lisse lisse (sans rainures)



LISSE LISSE PLAXÉ GRIS 7016 SABLÉ

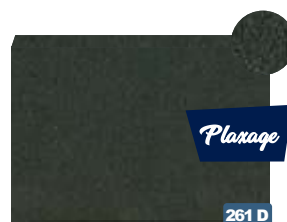









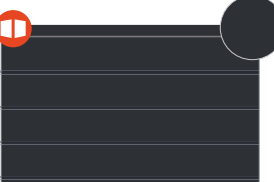

LISSE LISSE PLAXÉ NOIR 9005 SABLÉ

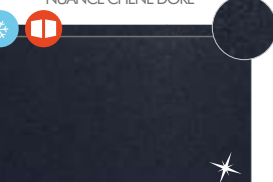

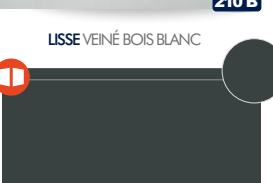
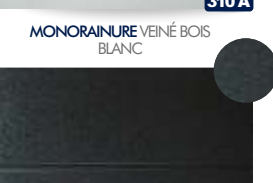
LISSE LISSE PLAXÉ PROCHE NOIR 2100 SABLÉ

45 modèles de p

RAINURÉ	LISSE		MONORAINURE	
 <p>RAINURÉ LISSE BLANC 101 A</p>	 <p>LISSE LISSE BLANC 201 B</p>	 <p>LISSE VEINÉ BOIS PLAXÉ NUANCE CHÊNE DORÉ 230 C</p>	 <p>MONORAINURE LISSE BLANC 301 A</p>	 <p>MONORAINURE VEINÉ BOIS BEIGE RAL 1015 313 B</p>
 <p>RAINURÉ LISSE GRIS RAL 7016 102 B</p>	 <p>LISSE LISSE GRIS RAL 7016 202 B</p>	 <p>LISSE LISSE GRIS RAL 7016 SABLÉ 240 D</p>	 <p>MONORAINURE LISSE GRIS RAL 7016 302 A</p>	 <p>MONORAINURE LISSE GRIS RAL 7016 SABLÉ 340 D</p>
 <p>RAINURÉ VEINÉ BOIS BLANC 110 A</p>	 <p>LISSE VEINÉ BOIS BLANC 210 B</p>	 <p>LISSE LISSE ROUGE RAL 3004 SABLÉ 241 D</p>	 <p>MONORAINURE VEINÉ BOIS BLANC 310 A</p>	 <p>MONORAINURE LISSE ROUGE RAL 3004 SABLÉ 341 D</p>
 <p>RAINURÉ VEINÉ BOIS GRIS RAL 7016 111 B</p>	 <p>LISSE VEINÉ BOIS BLANC 220 B</p>	 <p>LISSE LISSE NOIR RAL 9005 SABLÉ 242 D</p>	 <p>MONORAINURE VEINÉ BOIS BLANC 311 B</p>	 <p>MONORAINURE LISSE ROUGE RAL 3004 SABLÉ 342 D</p>
 <p>RAINURÉ VEINÉ BOIS PLAXÉ NUANCE CHÊNE DORÉ 130 B</p>	 <p>LISSE STRUCTURÉ GRIS ÉVOLUTION 221 B</p>	 <p>LISSE LISSE NOIR RAL 2100 SABLÉ 243 D</p>	 <p>MONORAINURE VEINÉ BOIS GRIS RAL 7016 312 B</p>	 <p>MONORAINURE LISSE NOIR RAL 9005 SABLÉ 343 D</p>
 <p>LISSE STRUCTURÉ NOIR MINÉRAL 260 D</p>	 <p>LISSE LISSE PLAXÉ GRIS 7016 SABLÉ 261 D</p>	 <p>LISSE LISSE PLAXÉ NOIR 9005 SABLÉ 262 D</p>	 <p>LISSE LISSE PLAXÉ GRIS 7016 270 B</p>	 <p>MONORAINURE LISSE GRIS RAL 2900 SABLÉ 344 D</p>
 <p>LISSE LISSE PLAXÉ GRIS 7016 SABLÉ 260 D</p>	 <p>LISSE LISSE PLAXÉ NOIR 9005 SABLÉ 261 D</p>	 <p>LISSE LISSE PLAXÉ PROCHE NOIR 2100 SABLÉ 262 D</p>	 <p>LISSE LISSE PLAXÉ CHÊNE BLANC NEW</p>	

Panneaux en standard

MONORAINURE HAUTE

MONORAINURE HAUTE LISSE BLANC **401 A**

MONORAINURE HAUTE LISSE NOIR RAL 9005 SABLÉ **442 D**

MONORAINURE HAUTE LISSE GRIS RAL 7016 **402 B**

MONORAINURE HAUTE LISSE NOIR RAL 2100 SABLÉ **443 D**

MONORAINURE HAUTE LISSE GRIS RAL 7016 SABLÉ **440 D**

MONORAINURE HAUTE LISSE GRIS RAL 2900 SABLÉ **444 D**

MONORAINURE HAUTE LISSE ROUGE RAL 3004 SABLÉ **441 D**

MONONERVURE

MONONERVURE LISSE BLANC **501 B**

MONONERVURE LISSE PLAXÉ NUANCE CHÊNE DORÉ **530 C**

CASSETTE

CASSETTE VEINÉ BOIS BLANC **610 B**

CASSETTE VEINÉ BOIS PLAXÉ NUANCE CHÊNE DORÉ **631 C**

BANDES VERTICALES

BANDES VERTICALES LISSE BLANC **701 C**

MICRORAINURES

MICRORAINURES LISSE BLANC **801 B**



Panneaux disponibles dans la gamme **Isola door**



Panneaux disponibles dans la gamme **Isobat**



Autres laquages RAL en option



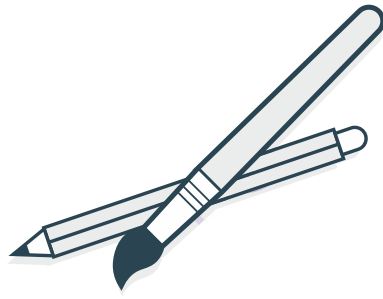

Personnalisations sans limites



Laissez libre cours à votre imagination : les créations les plus originales et décalées sont permises !

Grâce à un laquage de finition spécial, l'impression est parfaitement sublimée et préservée dans le temps

Mettez du relief sur vos créations grâce à l'impression directe 3D. Ce procédé original et exclusif donne de la profondeur à vos visuels.



impression
EN RELIEF



Autre alternative, le motif adhésif est une solution idéale pour créer votre motif ou lettrage personnalisé sur votre porte de garage.

La rampe d'éclairage LED intégrée, met en valeur votre porte de garage en consommant extrêmement peu d'énergie.





AVANT

Porte battante manuelle en bois
à remplacer à l'identique



APRÈS

Porte sectionnelle motorisée
avec impression sur panneaux



nalisation de votre porte



Découpes alunox assorties à votre porte d'entrée





nalisation de votre porte



MOTIFS ALUNOX

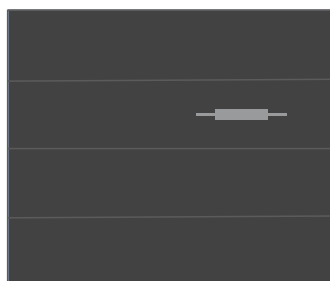

ART DECO 1

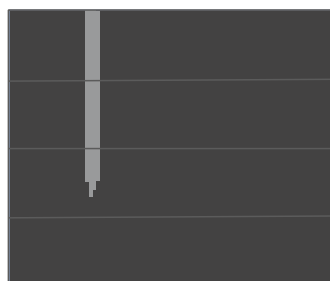

ART DECO 2

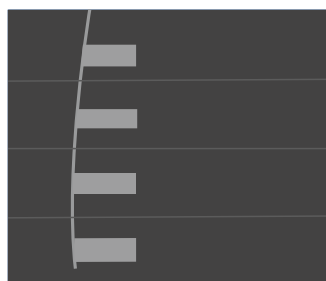

ART DECO 3

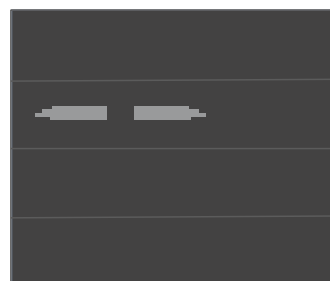

ART DECO 4

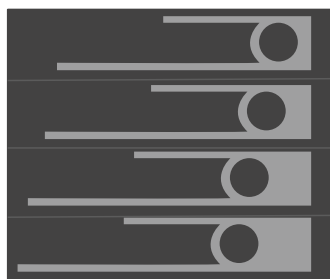

OCEAN

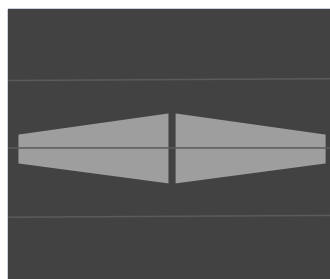

PERSPECTIVE

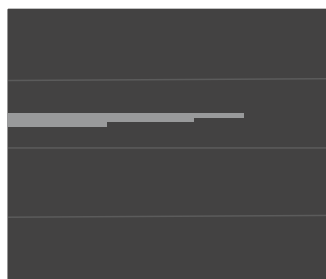

DEGRADE

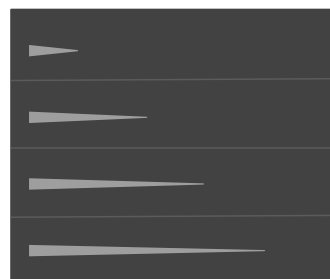

POINTE

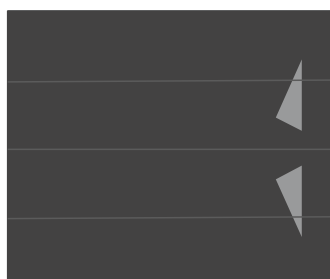

TRIANGLE

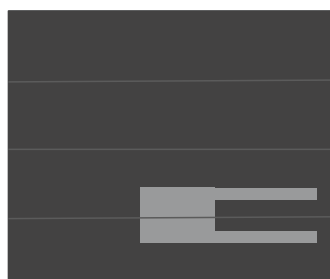

ETRIER

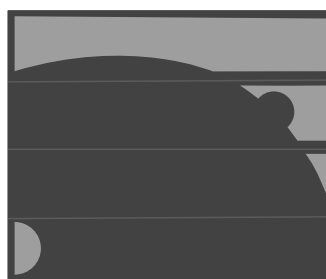

WAVE

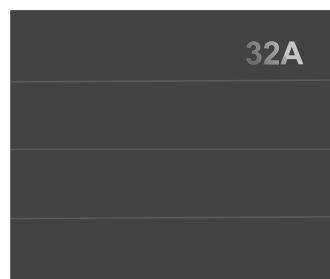

NUMERINOX
le chiffre ou la lettre (hauteur 150mm)

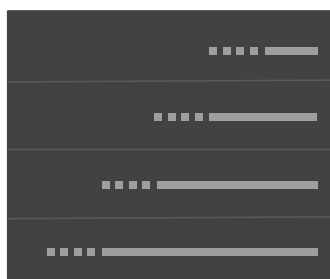

LINE DESIGN 1

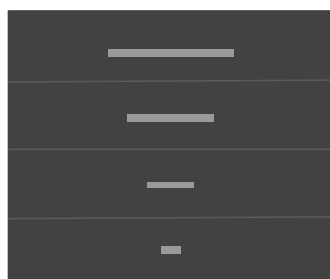

LINE DESIGN 2



LINE DESIGN 3

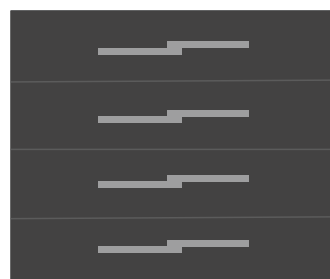

LINE DESIGN 4

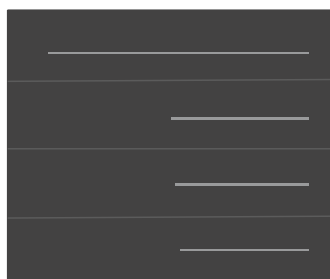

LINE DESIGN 5

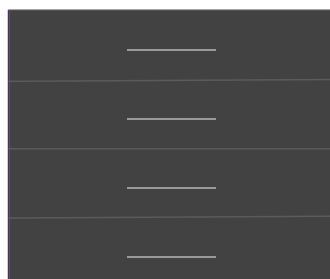

LINE DESIGN 6

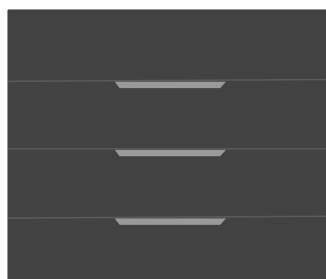

LINE DESIGN 7

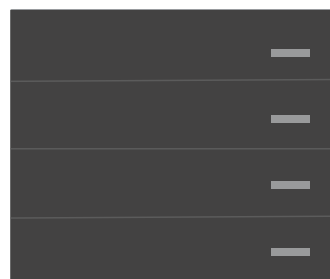

LINE DESIGN 8

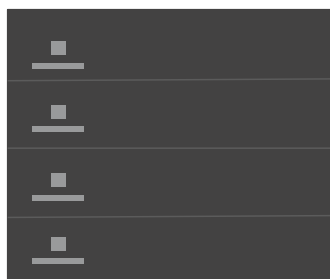

LINE DESIGN 9

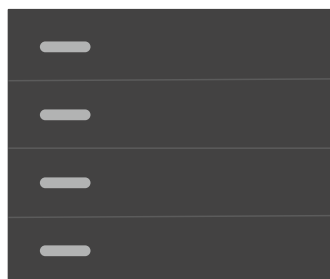

LINE DESIGN 10

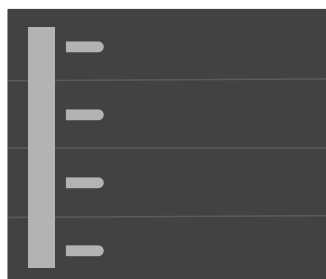

LINE DESIGN 11

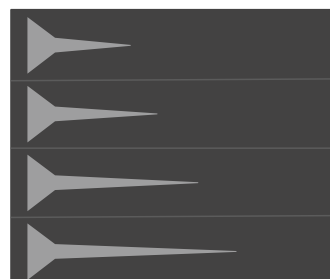

LINE DESIGN 12



Créez vous-même votre motif sur demande

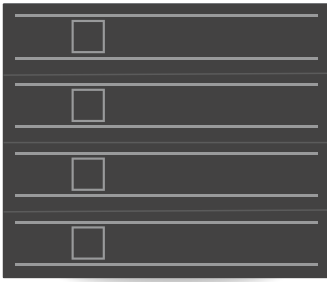

CUBO 1

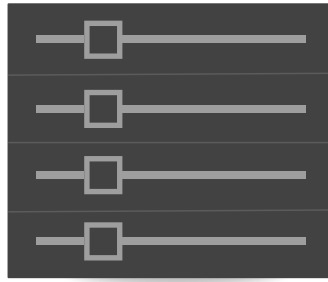

CUBO 2



CUBO 3

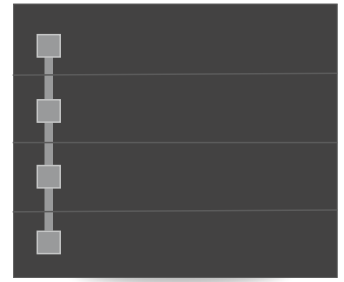

CUBO 4



CUBO 5



CUBO 6

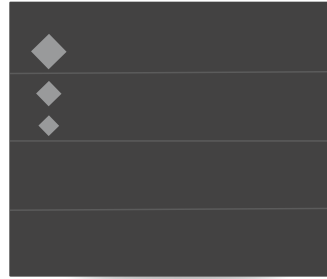

LOSANGE 1

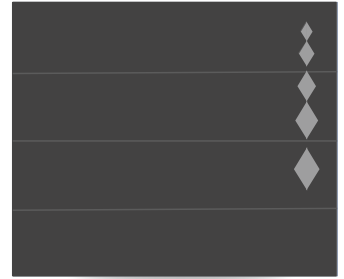

LOSANGE 2

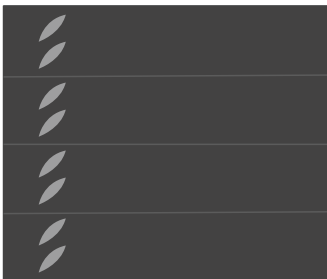

FEUILLAGE

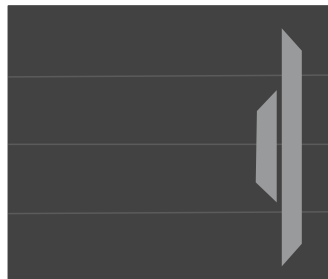

BAMBOU 1

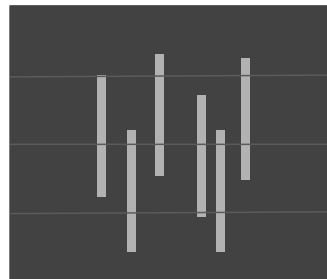

BAMBOU 2



BAMBOU 3

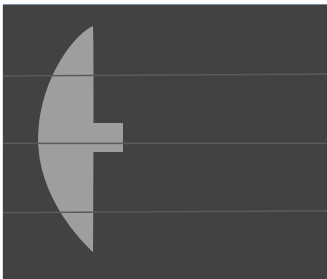

PARENTHESI 1

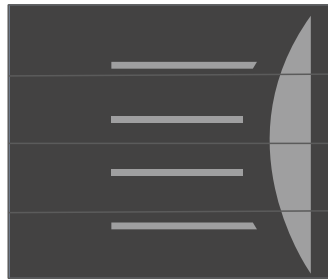

PARENTHESI 2

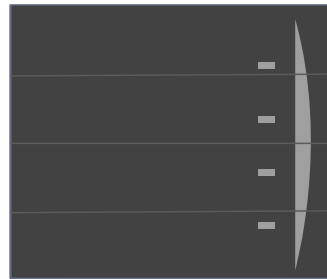

PARENTHESI 3

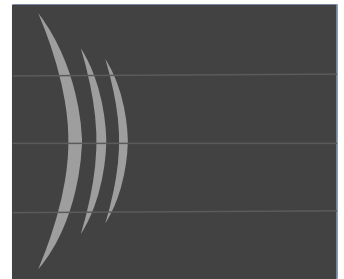

PARENTHESI 4

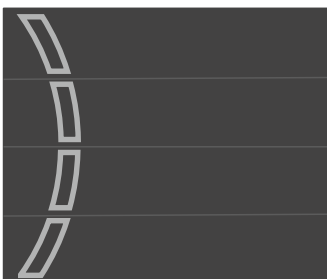

IRIS

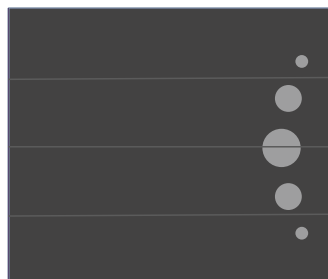

AQUA 1

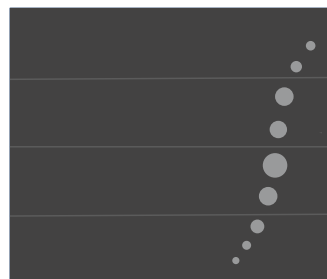

AQUA 2

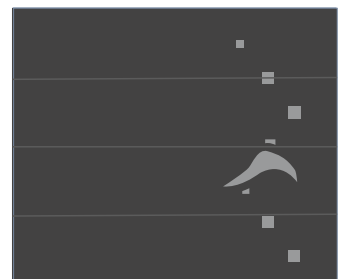

AQUA 3

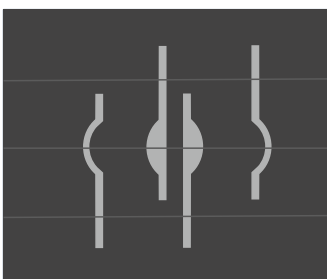

SOLFEGE

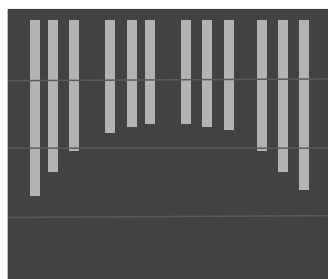

ASAHI

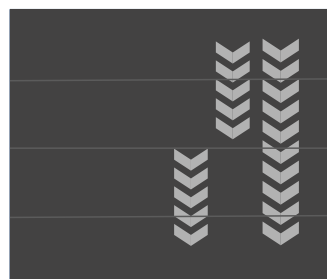

ARMY

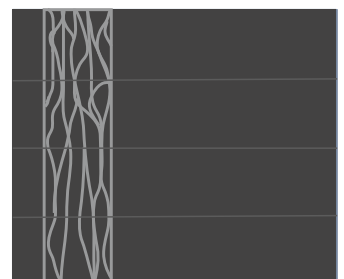

VEGETAL

Décorés disponibles uniquement sur des panneaux lisses lisses

Hublots Design

Pas disponible sur la gamme ISOPRIMA



Hublots disponibles dans la gamme

Isola door



Hublots disponibles dans la gamme

Isobat

HUBLOTS ALUNOX



VITRAGES



HUBLOTS LINE-TECH Hublot vitrage avec contour

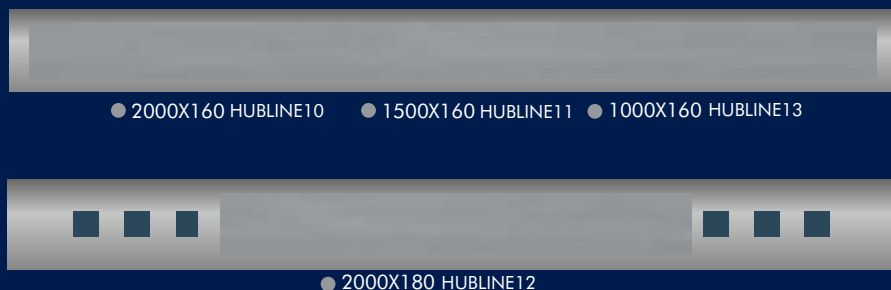

HUBLOTS LINE-TECH Hublot vitrage sans contour

Uniquement sur panneau lisse Laquage de la porte obligatoire

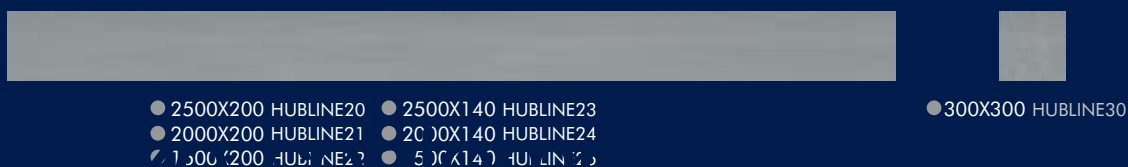



réflexe contemporain



Hublots Classiques



Hublots disponibles
dans la gamme
Isobat

HUBLOTS AVEC CADRE PVC

Double vitrage 4/10/44.2 dim. 490x325mm ou 530 x 360 (porte à cassettes)

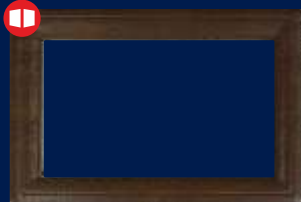
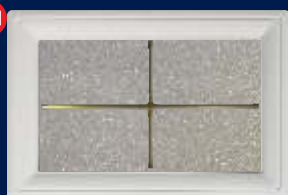

- HUB10
- HUB11
- HUB14
- HUB17

- HUB13
- HUB12
- HUB18

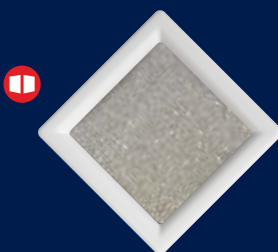
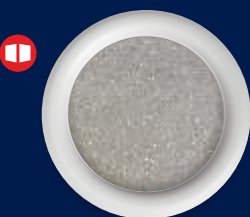

- Ø 318 HUB80
- Ø 318 HUB81
- Ø 318 HUB82

- 290x290 HUB90
- 290x290 HUB91
- 290x290 HUB92

- 290x290 HUB90L
- 290x290 HUB91L
- 290x290 HUB92L



- SANS MOTIF HUB00

- CROISILLON HUB01

- LOSANGE HUB02



- CHAPEAU DE GENDARME HUB03

- SOLEIL HUB05

- DEMI LUNE HUB06



- SOLEIL LEVANT HUB04-S3/S4/S5/S6 - (Fonction du nombre de hublots)

TYPES DE VITRAGES

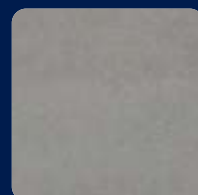

Double plexi
granité



Double vitrage
granité



Double vitrage
sablé



Double vitrage
Chinchilla

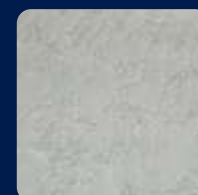

Double vitrage
Delta mat

TOUS LES MODÈLES RECTANGULAIRES DE LA
GAMME PRESTIGE ET GAMME CLASSIQUE SONT DISPONIBLES
EN CADRE FIN OU ÉPAIS, BLANC OU NUANCE CHÊNE DORÉ



laissez entrer la lumière



Accessoires

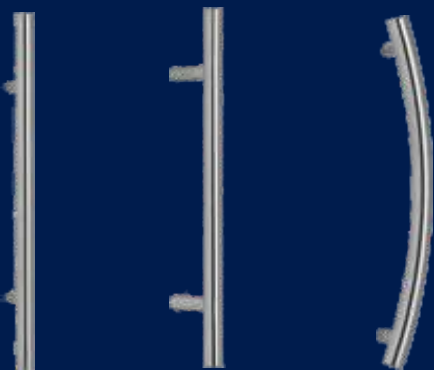

ROUND02

ROUND07

ROUND11

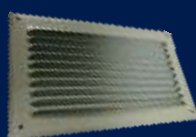

GRILLE DE VENTILATION
GRILLEVENT

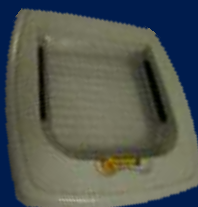

CHATIÈRE BLANCHE
CHATIERE
OU MARRON
CHATIEREM



POIGNÉE "PAR EN PAR"
634



LAQUAGE BOÎTE
AUX LETTRES
(Uniquement laquage
de l'entrée de boîte)
BAL4



POIGNÉE MARCHÉ PIED
641B



JOINT DOUBLE LÈVRE
(ml) 1035



AÉROSOL HUILE
LUBRIFIANTE
1063

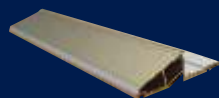

BARRE DE SEUIL
ALUMINIUM LATSEUIL





Motorisations & a

Motorisations



BOTTICELLI Nouvelle génération



Opérateurs électromécaniques pour usage intensif/très intensif, conçus pour la motorisation de portes de garage sectionnelles. S'adaptent parfaitement à tous types de contextes architecturaux, grâce à un grand choix de rails à chaîne ou à courroie de différentes longueurs. La centrale de commande gère la fin de course par encodeur intégré au moteur. La butée mécanique intégrée au rail sert de sécurité haute. Ouverture plus rapide d'environ 40%.

TIZIANO*



Avec ses 13 centimètres d'épaisseur seulement, TIZIANO est l'un des opérateurs les plus compacts du marché, ce qui lui permet une intégration parfaite à tout type de maison et d'architecture. Grâce au récepteur radio intégré à la centrale de commande, TIZIANO peut mémoriser le code de 10 télécommandes de la série MITTO ou KLEIO ou/et de systèmes de commande sans fil comme par exemple RB ou T-BOX.

*Sur portes Isoprime et Isoline pack standard

Radiocommandes



EMETTEUR
2 FONCTIONS
MITTO2



EMETTEUR
4 FONCTIONS
MITTO4



SUPPORT MURAL
POUR MITTO
B00R04

accessoires



Be ahead

Commandes murales



DIGICODE
ANTI-VANDALE
DIGIANTI



CLAVIER
RADIO À CODE
Q.BO TOUCH



DIGICODE INOX
AVEC 2 BADGES
DIGIANTIAIA



SÉLECTEUR À CLÉ
Q.BOKEY



BOUTON POUSSOIR
RADIO
RB / MIME PAD

Organes de sécurité



PHOTO-CELLULES
CLIGNOTANTES
THEA



CELLULES
ANTI-VANDALE
CELLULEANTI



FEU CLIGNOTANT
AVEC OU SANS ANTENNE
EN 24 OU 220V
BLTA024R2



ANTENNE
AEL433

Manoeuvres optionnelles



DÉVERROUILLAGE
EXTÉRIEUR
SETS



KIT BATTERIE POUR
EOS OU BOTTI AVEC
CENTRALE VENERE D
CB EOS



ALIMENTATION À
ÉNERGIE SOLAIRE AVEC
CENTRALE DE COMMANDE
NON DISPONIBLE AVEC MOTEUR TIZIANO

somfy®



Motorisation DEXO PRO
de la marque SOMFY
à courroie 800 Newtons
(En option avec plus value)

Radiocommandes

SOMFY **RTS**

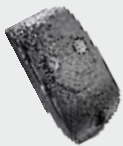

EMETTEUR KEYTIS
2 CANAUX RTS
SOMFYKEYTIS2



EMETTEUR KEYGO
4 CANAUX RTS
SOMFYKEYGORTS



SUPPORT
KEYGO
SOMFYSUPKEYGO



EMETTEUR
SITUO RTS
SITUORTSSOMFY

SOMFY **IO**



EMETTEUR KEYGO
1-WAY IO
SOMFYKEYGO



EMETTEUR KEYTIS
4 CANAUX IO
KEYTIS4IO



EMETTEUR KEYTIS
4 CANAUX HOME IO
KEYTIS4HOME



CLAVIER À CODE
RADIO MÉTALLIQUE IO
DIGIRAD2SOMFYIO

Commandes murales



CLAVIER À CODE
RADIO RTS
DIGIRAD1SOMFY



CLAVIER À CODE
RADIO MÉTAL RTS
DIGIRAD2SOMFY



SÉLECTEUR À CLÉ
Q.BOKEY



COMMANDE
MURALE RTS
EMURSOMFY

Organes de sécurité



CÉLULES
PHOTOÉLECTRIQUES
DESMEA15



FEU ORANGE 24 V
AVEC ANTENNE RTS
GYRORTSSOMFY



DÉVERROUILLAGE
EXTÉRIEUR
SETS



BATTERIE SECOURS
BATSOMFYIO

Manoeuvres optionnelles

SOMMER



Radiocommandes



EMETTEUR PEARL
4 VOIES 868,8 MHZ
PEARL



EMETTEUR PEARL VIBE
4 VOIES 868,8 MHZ
PEARLVIBE



SUPPORT ÉMETTEUR
4 VOIES
SUPEPEARL



EMETTEUR SLIDER
4 VOIES 868,8 MHZ
EMSOMMERSLIDE

Commandes murales



EMETTEUR
BIOMÉTRIQUE
EMBIOSOMMER



COMMANDE MURALE
RADIO ANTHRACITE
3 CANAUX
EMURSOMMER



SÉLECTEUR À CLÉ
Q.BOKEY



DIGICODE RADIO
10 CANAUX
DIGIRADSOM

Organes de sécurité



CÉLULES
PHOTOÉLECTRIQUES
DESMEA15



FEU CLIGNOTANT
AVEC OU SANS ANTENNE
EN 24 OU 220V
BLTA024R2



DÉVERROUILLAGE
EXTÉRIEUR
1702E

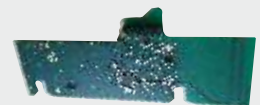

CARTE SOMMER
DELTA DORE X3D
CARTEX3D

Manoeuvres optionnelles

Interphonie - Vidéophonie



Fournisseur de bien-être



KIT VIDEOPHONE WI FI EN SAILLIE
KITVIDEOSAIWIFI
 KIT VIDEOPHONE WI FI ENCASTRÉ
KITVIDEOSEAIWIFI



CONNECTEZ JUSQU'À
8 SMARTPHONES



Apps disponible sur

KIT VIDEOPHONE EN SAILLIE
KITVIDEOSAI



KIT AUDIO EN SAILLIE
KITAUDIOSAI



KIT WL-11 CARILLON
VIDEO SANS FIL
KITCARRILLON



c'est aussi



Portes industrielles



Rideaux métalliques



Grilles à mailles



Motorisations de portails











Consultez notre
bibliothèque photos de
réalisations sur notre site

www.sda-bft.com



VOTRE INSTALLATEUR AGRÉÉ
prix indicatif 3.00€